

Lineaflex

sedie poltroncine poltrone divani

MADE IN ITALY

Lineaflex

sedie poltroncine poltrone divani
chairs armchairs sofas

PER SPAZI PUBBLICI E PRIVATI
FOR COMMERCIAL OR DOMESTIC SPACES



MADE IN ITALY

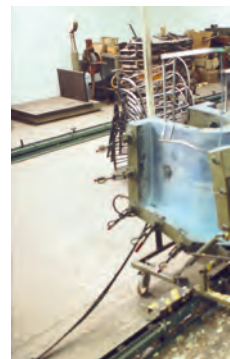

Lineaflex

sedie poltroncine poltrone divani
chairs armchairs sofas

LE NOSTRE **STRUTTURE** SONO IN **ACCIAIO**
ALL OUR **FRAMES** ARE MADE OF **STEEL**





I prodotti Lineaflex sono prodotti di **ALTA QUALITA'**.
LE SEDUTE in POLIURETANO STAMPATO a FREDDO
con STRUTTURA IN ACCIAIO, **GARANTISCONO**
ELEVATA DURATA e **QUALITA' SUPERIORE**
rispetto alle SEDUTE PRODOTTE con il
SISTEMA TRADIZIONALE.
REALIZZAMO SU RICHIESTA STRUTTURE in
ACCIAIO, MODELLI e STAMPI da DISEGNI in 3D
e CAMPIONI.

LINEAFLEX provides HIGH-QUALITY products.

*OUR COLD-CURE POLYURETHANE FOAM SEATS
with STEEL FRAMES ENSURE DURABILITY and
GREATER QUALITY than PRODUCTS FABRICATED
with STANDARD PROCESSES.*

*WE CREATE BESPOKE STEEL FRAMES,
PROTOTYPES and MOULDS FROM 3D DESIGNS, and
SAMPLES on DEMAND.*

INDICE INDEX

SEDIE • CHAIRS



cod. 164
page 12



cod. 167
page 14



cod. 168 B
page 16



cod. 168 A
page 16



cod. 180 A
page 18

POLTRONCINE • ARMCHAIRS



cod. 101
page 28



cod. 180 B
page 19



cod. 200
page 31



cod. 230
page 27

POLTRONCINE • ARMCHAIRS



cod. 244 A
page 36



cod. 244 B
page 36



cod. 260
page 35



cod. 263 B
page 34



cod. 263 A
page 34



cod. 283
page 33



cod. 284
page 29



cod. 285
page 30



cod. 1999
page 32

POLTRONE • ARMCHAIRS



cod. 165
page 44



cod. 227
page 45



cod. 235
page 23



cod. 238
page 43



cod. 248 B
page 22



cod. 248 A
page 22



cod. 249 B
page 25



cod. 249 A
page 25



cod. 262
page 46

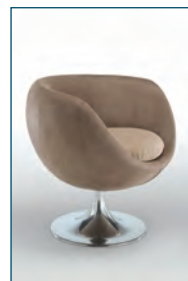

cod. 281
page 40



cod. 333
page 24



cod. 340
page 39

POLTRONE • ARMCHAIRS



cod. 2004
page 47



cod. 2015
page 41



cod. 160
page 55



cod. 190
page 49



cod. 205
page 52



cod. 205
page 53



cod. 210
page 54



cod. 2002
page 51



cod. 170
page 50

RELAX

DIVANETTI • SOFAS



cod. 140
page 59



cod. 161
page 61

L'azienda si riserva il diritto di apportare modifiche o di cessare la produzione degli articoli senza nessun preavviso.
We reserve the right to discontinue products and to amend their design and/or specifications without notice.

DIVANI • SOFAS



cod. 163
page 58



cod. 163
page 58



cod. 163
page 57



LINEAFLEX è un'azienda specializzata nella produzione di sedie, poltrone, poltroncine e divani.

I prodotti **LINEAFLEX** sono realizzati secondo tradizione e innovazione, con strutture in acciaio. Le imbottiture sono in poliuretano schiumato flessibile a freddo.

Inoltre la produzione **LINEAFLEX** può anche essere realizzata con materiale ignifugo in classe 1.

La ricchezza e versatilità delle forme rende i prodotti **LINEAFLEX** adattabili a spazi e ambienti diversi, pubblici e privati.

LINEAFLEX is an Italian furniture manufacturer specialising in chairs, armchairs, occasional chairs and sofas.

LINEAFLEX combines tradition and innovation, and uses only the best materials to create products of supreme quality. All our frames are made of steel; paddings are made of cold-cure flexible polyurethane foam.

Every product in our collection can be manufactured with the safest fireproof materials.

Thanks to versatile designs and refined forms, LINEAFLEX products sit well both within the commercial and domestic environment.

Lineaflex

COMFORT

PER OGNI TUA ESIGENZA
FOR EVERY NEED



cod. **164**

164



164

VARIANTI GAMBE • SELECTION OF LEGS

- . LEGNO • WOOD
- . METALLO VERNICIATO • PAINTED METAL
- . METALLO CROMATO • CHROME-PLATED METAL



164

SEDIA • CHAIR

L (W) 44 - H 95 - P (D) 55

Peso • Weight: **7,3 Kg.**

Tessuto per rivestimento • Upholstery fabric: **1,50 mt.**



SCOCCA • SHELL

Struttura in acciaio, interamente stampata in poliuretano schiumato a freddo.

Steel frame, cold-cure moulded polyurethane foam.

VARIANTI GAMBE • SELECTION OF LEGS

. LEGNO • WOOD

. METALLO VERNICIATO • PAINTED METAL

. METALLO CROMATO • CHROME-PLATED METAL

cod. **167**



VARIANTI GAMBE • SELECTION OF LEGS
• LEGNO • *WOOD*
• METALLO VERNICIATO • *PAINTED METAL*
• METALLO CROMATO • *CHROME-PLATED METAL*

167

SEDIA schienale basso • *CHAIR with low backrest*

L (W) 44 - H 85 - P (D) 55

Peso • *Weight: 7,3 Kg.*

Tessuto per rivestimento • *Upholstery fabric: 1,40 mt.*

SCOCCA • SHELL

Struttura in acciaio, interamente stampata in poliuretano schiumato a freddo.
Steel frame, cold-cure moulded polyurethane foam.



cod. 168



168 A



168 B

VARIANTI GAMBE • SELECTION OF LEGS
. LEGNO • WOOD
. METALLO VERNICIATO • PAINTED METAL
. METALLO CROMATO • CHROME-PLATED METAL



168 A

SEDIA con braccioli • CHAIR with armrests

L (W) 55 - H 90 - P (D) 60

Peso • Weight: 7 Kg.

Tessuto per rivestimento • Upholstery fabric: 1,20 mt.

SCOCCA • SHELL

Struttura in acciaio, interamente stampata in poliuretano schiumato a freddo.
Steel frame, cold-cure moulded polyurethane foam.



168 B

SEDIA • CHAIR

L (W) 47 - H 90 - P (D) 60

Peso • Weight: 7 Kg.

Tessuto per rivestimento • Upholstery fabric: 1,20 mt.

SCOCCA • SHELL

Struttura in acciaio, interamente stampata in poliuretano schiumato a freddo.
Steel frame, cold-cure moulded polyurethane foam.

cod. **180 A**

180 A

SEDIA senza braccioli • *CHAIR without armrests*

L (W) 56 - H 85 - P (D) 53

Peso • *Weight: 9,2 Kg.*

Tessuto per rivestimento • *Upholstery fabric: 2 mt.*

SCOCCA • *SHELL*

Struttura in acciaio, interamente stampata in poliuretano schiumato a freddo.

Steel frame, cold-cure moulded polyurethane foam.



VARIANTI GAMBE • *SELECTION OF LEGS*

. LEGNO • *WOOD*

. METALLO VERNICIATO • *PAINTED METAL*

. METALLO CROMATO • *CHROME-PLATED METAL*

cod. **180 B**



VARIANTI GAMBE • SELECTION OF LEGS

- . LEGNO • WOOD
- . METALLO VERNICIATO • PAINTED METAL
- . METALLO CROMATO • CHROME-PLATED METAL
- . BASE GIREVOLE • SWIVEL BASE

180 B

POLTRONCINA con braccioli • *ARMCHAIR with armrests*

L (W) 56 - H 85 - P (D) 53

Peso • *Weight*: 10,50 Kg.

Tessuto per rivestimento • *Upholstery fabric*: 2,20 mt.

SCOCCA • SHELL

Struttura in acciaio, interamente stampata in poliuretano schiumato a freddo.
Steel frame, cold-cure moulded polyurethane foam.





COMFORT



cod. **248****248 A**

POLTRONA base girevole • *ARMCHAIR with swivel base*
 L (W) 73 - H 110 - P (D) 73

Peso • *Weight: 20 Kg.*

Tessuto per rivestimento • *Upholstery fabric: 3,10 mt.*

248 B

POLTRONA base girevole • *ARMCHAIR with swivel base*
 L (W) 73 - H 110 - P (D) 73

Peso • *Weight: 20 Kg.*

Tessuto per rivestimento • *Upholstery fabric: 3,10 mt.*

SCOCCA • SHELL

Struttura in acciaio, interamente stampata in poliuretano schiumato a freddo.
Steel frame, cold-cure moulded polyurethane foam.

cod. **235**



235

POLTRONA • *ARMCHAIR*

L (W) 63,5 - H 74 - P (D) 60

Peso • *Weight*: 12,5 Kg.

Tessuto per rivestimento • *Upholstery fabric*: 3 mt.

SCOCCA • SHELL

Struttura in acciaio, interamente stampata in poliuretano schiumato a freddo.

Steel frame, cold-cure moulded polyurethane foam.

cod. **333**



333

POLTRONA • *ARMCHAIR*

L (W) 75 - H 83 - P (D) 75

Peso • *Weight*: 16,2 Kg.

Tessuto per rivestimento • *Upholstery fabric*: 4 mt.

SCOCCA • SHELL

Struttura in acciaio, interamente stampata in poliuretano schiumato a freddo.

Steel frame, cold-cure moulded polyurethane foam.

cod. **249****249 B**POLTRONA base girevole • *ARMCHAIR with swivel base*

L (W) 74 - H 76 - P (D) 64

Peso • *Weight*: 18 Kg.Tessuto per rivestimento • *Upholstery fabric*: 2,70 mt.**249 A**POLTRONA base girevole • *ARMCHAIR with swivel base*

L (W) 74 - H 76 - P (D) 64

Peso • *Weight*: 18 Kg.Tessuto per rivestimento • *Upholstery fabric*: 2,70 mt.**SCOCCA • SHELL**

Struttura in acciaio, interamente stampata in poliuretano schiumato a freddo.

Steel frame, cold-cure moulded polyurethane foam.



COMFORT

AL RISTORANTE
at the restaurant

cod. **230**



230 A

POLTRONCINA • *ARMCHAIR*

L (W) 60 - H 80 - P (D) 59

Peso • *Weight*: 9 Kg.

Tessuto per rivestimento • *Upholstery fabric*: 1,50 mt.

SCOCCA • *SHELL*

Struttura in acciaio, interamente stampata in poliuretano schiumato a freddo.

Steel frame, cold-cure moulded polyurethane foam.

230 B

**LE GAMBE POTRANNO ESSERE RIVESTITE IN PELLE O TESSUTO DAL VOSTRO TAPPEZZIERE •
LEGS CAN BE UPHOLSTERED WITH LEATHER OR FABRIC BY YOUR DECORATOR**

cod. **101**

101

POLTRONCINA • *ARMCHAIR*

L (W) 62 - H 75 - P (D) 58

Peso • *Weight*: 10 Kg.

Tessuto per rivestimento • *Upholstery fabric*: 2,80 mt.

SCocca • SHELL

Struttura in acciaio, interamente stampata in poliuretano schiumato a freddo.

Steel frame, cold-cure moulded polyurethane foam.



cod. **284**



284

POLTRONCINA • *ARMCHAIR*

L (W) 57 - H 80 - P (D) 58

Peso • *Weight*: 11 Kg.

Tessuto per rivestimento • *Upholstery fabric*: 1,50 mt.

VARIANTI GAMBE • SELECTION OF LEGS

. LEGNO • *WOOD*

. METALLO VERNICIATO • *PAINTED METAL*

. METALLO CROMATO • *CHROME-PLATED METAL*

. BASE GIREVOLE • *SWIVEL BASE*

SCocca • SHELL

Struttura in acciaio, interamente stampata in poliuretano schiumato a freddo.

Steel frame, cold-cure moulded polyurethane foam.

cod. **285****285**POLTRONCINA • *ARMCHAIR*

L (W) 57 - H 80 - P (D) 58

Peso • *Weight*: 11 Kg.Tessuto per rivestimento • *Upholstery fabric*: 1,50 mt.**SCOCCA • SHELL**

Struttura in acciaio, interamente stampata in poliuretano schiumato a freddo.
Steel frame, cold-cure moulded polyurethane foam.

VARIANTI GAMBE • SELECTION OF LEGS

- . LEGNO • *WOOD*
- . METALLO VERNICIATO • *PAINTED METAL*
- . METALLO CROMATO • *CHROME-PLATED METAL*
- . BASE GIREVOLE • *SWIVEL BASE*

cod. **200**



200

POLTRONCINA • *ARMCHAIR*

L (W) 60 - H 79 - P (D) 57

Peso • *Weight*: 9 Kg.

Tessuto per rivestimento • *Upholstery fabric*: 2,20 mt.

VARIANTI GAMBE • SELECTION OF LEGS

. METALLO VERNICIATO • *PAINTED METAL*

. METALLO CROMATO • *CHROME-PLATED METAL*

. BASE GIREVOLE • *SWIVEL BASE*

SCOCCA • SHELL

Struttura in acciaio, interamente stampata in poliuretano schiumato a freddo.

Steel frame, cold-cure moulded polyurethane foam.

cod. **1999**



1999

POLTRONCINA base girevole • *ARMCHAIR with swivel base*

L (W) 56 - H 79 - P (D) 72

Peso • *Weight*: **12,3 Kg.**

Tessuto per rivestimento • *Upholstery fabric*: **2 mt.**

SCOCCA • SHELL

Struttura in acciaio, interamente stampata in poliuretano schiumato a freddo.

Steel frame, cold-cure moulded polyurethane foam.

cod. **283**



283

POLTRONCINA • *ARMCHAIR*

L (W) 57 - H 80 - P (D) 58

Peso • *Weight*: 11 Kg.

Tessuto per rivestimento • *Upholstery fabric*: 1,50 mt.

VARIANTI GAMBE • SELECTION OF LEGS

- . LEGNO • *WOOD*
- . METALLO VERNICIATO • *PAINTED METAL*
- . METALLO CROMATO • *CHROME-PLATED METAL*
- . BASE GIREVOLE • *SWIVEL BASE*

SCOCCA • SHELL

Struttura in acciaio, interamente stampata in poliuretano schiumato a freddo.
Steel frame, cold-cure moulded polyurethane foam.

cod. **263****263 A**POLTRONCINA base girevole • *ARMCHAIR with swivel base*

L (W) 59 - H 74 - P (D) 60

Peso • *Weight*: 15 Kg.Tessuto per rivestimento • *Upholstery fabric*: 2,30 mt.**SCOCCA • SHELL**

Struttura in acciaio, interamente stampata in poliuretano schiumato a freddo.

*Steel frame, cold-cure moulded polyurethane foam.***263 B**POLTRONCINA • *ARMCHAIR*

L (W) 59 - H 74 - P (D) 60

Peso • *Weight*: 11,8 Kg.Tessuto per rivestimento • *Upholstery fabric*: 2,30 mt.**SCOCCA • SHELL**

Struttura in acciaio, interamente stampata in poliuretano schiumato a freddo.

Steel frame, cold-cure moulded polyurethane foam.

cod. **260**



260

POLTRONCINA • *ARMCHAIR*

L (W) 59 - H 78 - P (D) 54

Peso • *Weight*: **9 Kg.**

Tessuto per rivestimento • *Upholstery fabric*: **1,50 mt.**

SCocca • SHELL

Struttura in acciaio, interamente stampata in poliuretano schiumato a freddo.

Steel frame, cold-cure moulded polyurethane foam.

cod. **244****244 A**POLTRONCINA • *ARMCHAIR*

L (W) 59 - H 74 - P (D) 60

Peso • *Weight*: **12,3 Kg.**Tessuto per rivestimento • *Upholstery fabric*: **2,30 mt.****SCOCCA • SHELL**Struttura in acciaio, interamente stampata in poliuretano schiumato a freddo.
*Steel frame, cold-cure moulded polyurethane foam.***244 B**POLTRONCINA base girevole • *ARMCHAIR with swivel base*

L (W) 59 - H 74 - P (D) 60

Peso • *Weight*: **15 Kg.**Tessuto per rivestimento • *Upholstery fabric*: **2,30 mt.****SCOCCA • SHELL**Struttura in acciaio, interamente stampata in poliuretano schiumato a freddo.
Steel frame, cold-cure moulded polyurethane foam.





cod. **340****340 A**POLTRONA con piedini in metallo • *ARMCHAIR with metal feet*

L (W) 56 - H 81 - P (D) 54

Peso • *Weight: 12,3 Kg.*Tessuto per rivestimento • *Upholstery fabric: 3,50 mt.***SCOCCA • SHELL**Struttura in acciaio, interamente stampata in poliuretano schiumato a freddo.
*Steel frame, cold-cure moulded polyurethane foam.***340 B**POLTRONA con ruote • *ARMCHAIR with wheels*

L (W) 56 - H 81 - P (D) 54

Peso • *Weight: 12,3 Kg.*Tessuto per rivestimento • *Upholstery fabric: 3,50 mt.***SCOCCA • SHELL**Struttura in acciaio, interamente stampata in poliuretano schiumato a freddo.
Steel frame, cold-cure moulded polyurethane foam.

cod. **281**



281

POLTRONA base girevole • *ARMCHAIR with swivel base*

L (W) 76 - H 72 - P (D) 66

Peso • *Weight*: **15,2 Kg.**

Tessuto per rivestimento • *Upholstery fabric*: **2,50 mt.**

SCOCCA • SHELL

Struttura in acciaio, interamente stampata in poliuretano schiumato a freddo.

Steel frame, cold-cure moulded polyurethane foam.

cod. **2015**



2015

POLTRONA • *ARMCHAIR*

L (W) 73 - H 99 - P (D) 90

Peso • *Weight*: **15,9 Kg.**

Tessuto per rivestimento • *Upholstery fabric*: **4 mt.**

SCocca • SHELL

Struttura in acciaio, interamente stampata in poliuretano schiumato a freddo.

Steel frame, cold-cure moulded polyurethane foam.



cod. **238**



238

POLTRONA • *ARMCHAIR*

L (W) 90 - H 80 - P (D) 86

Peso • *Weight*: **25,9 Kg.**

Tessuto per rivestimento • *Upholstery fabric*: **5 mt.**

SCocca • SHELL

Struttura in acciaio, interamente stampata in poliuretano schiumato a freddo.

Steel frame, cold-cure moulded polyurethane foam.

cod. **165**



165

POLTRONA • *ARMCHAIR*

L (W) 71 - H 80 - P (D) 70

Peso • *Weight*: **13,9 Kg.**

Tessuto per rivestimento • *Upholstery fabric*: **3,80 mt.**

SCocca • SHELL

Struttura in acciaio, interamente stampata in poliuretano schiumato a freddo.
Steel frame, cold-cure moulded polyurethane foam.

cod. **227**

227

POLTRONA • *ARMCHAIR*

L (W) 68 - H 70 - P (D) 67

Peso • *Weight*: **14,3 Kg.**

Tessuto per rivestimento • *Upholstery fabric*: **3,50 mt.**

SCocca • SHELL

Struttura in acciaio, interamente stampata in poliuretano schiumato a freddo.

Steel frame, cold-cure moulded polyurethane foam.



cod. **262**



262

POLTRONA • *ARMCHAIR*

L (W) 72 - H 85 - P (D) 70

Peso • *Weight*: 15 Kg.

Tessuto per rivestimento • *Upholstery fabric*: 3,60 mt.

SCocca • SHELL

Struttura in acciaio, interamente stampata in poliuretano schiumato a freddo.

Steel frame, cold-cure moulded polyurethane foam.

cod. **2004**



2004

POLTRONA • *ARMCHAIR*

L (W) 64 - H 80 - P (D) 80

Peso • *Weight*: 16 Kg.

Tessuto per rivestimento • *Upholstery fabric*: 3,60 mt.

SCOCCA • SHELL

Struttura in acciaio, interamente stampata in poliuretano schiumato a freddo.

Steel frame, cold-cure moulded polyurethane foam.



cod. **190**



190

POLTRONA • *ARMCHAIR*

L (W) 83 - H 107 - P (D) 86

Peso • *Weight*: **24,5 Kg.**

Tessuto per rivestimento • *Upholstery fabric*: **5 mt.**

SCOCCA • SHELL

Struttura in acciaio, interamente stampata in poliuretano schiumato a freddo.

Steel frame, cold-cure moulded polyurethane foam.

cod. **170**



170

POUFF • *POUFF*

L (W) 42 - H 42 - P (D) 42

Peso • *Weight*: 4,30 Kg.

Tessuto per rivestimento • *Upholstery fabric*: 1,50 mt.

SCocca • SHELL

Struttura in acciaio, interamente stampata in poliuretano schiumato a freddo.

Steel frame, cold-cure moulded polyurethane foam.

cod. **2002**

2002

POLTRONA • *ARMCHAIR*

L (W) 79 - H 103 - P (D) 82

Peso • *Weight*: **24,5 Kg.**

Tessuto per rivestimento • *Upholstery fabric*: **5 mt.**

SCOCCA • *SHELL*

Struttura in acciaio, interamente stampata in poliuretano schiumato a freddo.

Steel frame, cold-cure moulded polyurethane foam.



mod. **205**



205 classica *classical*

POLTRONA RELAX • *ARMCHAIR*
meccanismo manuale • *manual function*

L (W) 80 - H 100 - P (D) 85

Peso • *Weight*: **51 Kg.**

Tessuto per rivestimento • *Upholstery fabric*: **5 mt.**

SCOCCA • *SHELL*

Struttura in acciaio, interamente stampata in poliuretano schiumato a freddo.

Steel frame, cold-cure moulded polyurethane foam.

mod. **205**



205 classica *classical*

POLTRONA RELAX • *ARMCHAIR*
meccanismo elettrico a due motori • *dual motor powered*
alza persona • *incline and recline mechanism*
schienale e pediera indipendenti • *independent backrest and footrest*
L (W) 80 - H 100 - P (D) 85
Peso • *Weight: 51 Kg.*
Tessuto per rivestimento • *Upholstery fabric: 5 mt.*

SCOCCA • *SHELL*

Struttura in acciaio, interamente stampata in poliuretano schiumato a freddo.
Steel frame, cold-cure moulded polyurethane foam.

cod. **210**

210 moderna *modern*

POLTRONA RELAX • ARMCHAIR

meccanismo elettrico a due motori • *dual motor powered*

alza persona • *incline and recline mechanism*

schienale e pediera indipendenti • *independent backrest and footrest*

L (W) 82 - H 102 - P (D) 90

Peso • *Weight: 53 Kg.*

Tessuto per rivestimento • *Upholstery fabric: 5 mt.*

SCOCCA • SHELL

Struttura in acciaio, interamente stampata in poliuretano schiumato a freddo.

Steel frame, cold-cure moulded polyurethane foam.

cod. **160**



160

POLTRONA • *ARMCHAIR*

L (W) 78 - H 85 - P (D) 70

Peso • *Weight*: 16,5 Kg.

Tessuto per rivestimento • *Upholstery fabric*: 3,50 mt.

SCocca • SHELL

Struttura in acciaio, interamente stampata in poliuretano schiumato a freddo.

Steel frame, cold-cure moulded polyurethane foam.



cod. 163

Peso • Weight: 8 Kg.

Tessuto per rivestimento •
Upholstery fabric: 2,20 mt.

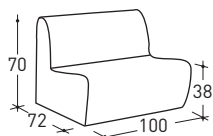

Peso • Weight: 16 Kg.

Tessuto per rivestimento •
Upholstery fabric: 3,50 mt.

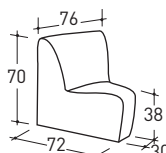
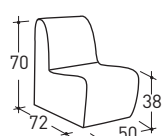

Peso • Weight: 9 Kg.

Tessuto per rivestimento •
Upholstery fabric: 3,00 mt.

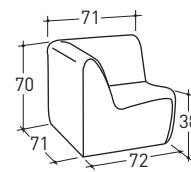
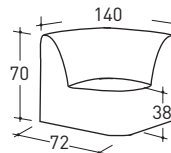

Peso • Weight: 16 Kg.

Tessuto per rivestimento •
Upholstery fabric: 3,50 mt.

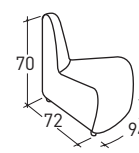

Peso • Weight: 9 Kg.

Tessuto per rivestimento •
Upholstery fabric: 3,00 mt.



Esempio di composizione
Example of composition

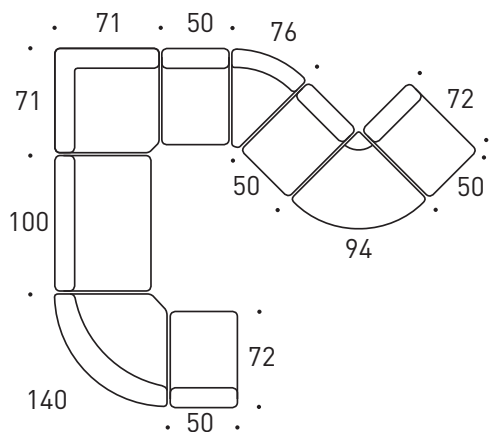

163

DIVANO composizione • SOFA composition

SCOCCA • SHELL

Struttura in acciaio, interamente stampata in poliuretano schiumato a freddo.
Steel frame, cold-cure moulded polyurethane foam.

cod. **163**

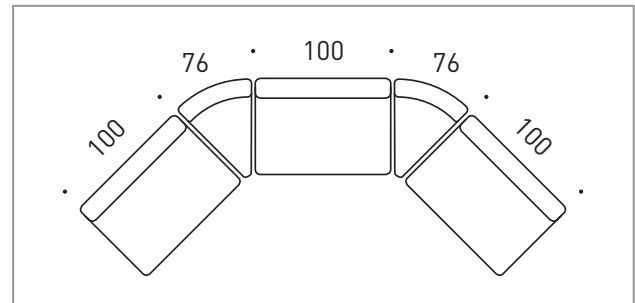
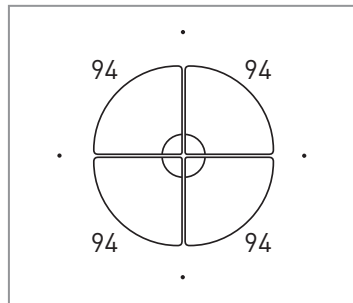

Alcuni esempi di composizione
Some examples of composition



cod. **140**

140 B



140 A

**140 A • 140 B**POLTRONCINA con ruote o piedini • *ARMCHAIR with wheels or feet*

L (W) 66 - H 74 - P (D) 62

Peso • *Weight*: 11,4 Kg.Tessuto per rivestimento • *Upholstery fabric*: 2,85 mt.**SCOCCA • SHELL**

Struttura in acciaio, interamente stampata in poliuretano schiumato a freddo.

*Steel frame, cold-cure moulded polyurethane foam.***140**DIVANO con ruote o piedini • *SOFA with wheels or feet*

L (W) 127 - H 74 - P (D) 62

Peso • *Weight*: 18,8 Kg.Tessuto per rivestimento • *Upholstery fabric*: 4,60 mt.**SCOCCA • SHELL**

Struttura in acciaio, interamente stampata in poliuretano schiumato a freddo.

Steel frame, cold-cure moulded polyurethane foam.



cod. **161**

161 A

161 B



161 A • 161 B

POLTRONCINA con ruote o piedini • *ARMCHAIR with wheels or feet*

L (W) 64 - H 77 - P (D) 66

Peso • *Weight: 11,6 Kg.*

Tessuto per rivestimento • *Upholstery fabric: 2,85 mt.*

SCOCCA • SHELL

Struttura in acciaio, interamente stampata in poliuretano schiumato a freddo.

Steel frame, cold-cure moulded polyurethane foam.

161

DIVANO con ruote o piedini • *SOFA with wheels or feet*

L (W) 115 - H 77 - P (D) 66

Peso • *Weight: 17,7 Kg.*

Tessuto per rivestimento • *Upholstery fabric: 4,60 mt.*

SCOCCA • SHELL

Struttura in acciaio, interamente stampata in poliuretano schiumato a freddo.

Steel frame, cold-cure moulded polyurethane foam.

CAMPIONARIO COLORI • AVAILABLE COLOURS

SI EFFETTUANO VERNICIATURE a CAMPIONE con un ORDINE di ALMENO 30 SEDIE o POLTRONE.
WE OFFER A CUSTOM PAINTWORK SERVICE FOR A MINIMUM ORDER OF 30 CHAIRS OR ARMCHAIRS.

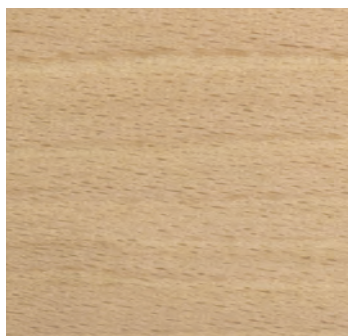

naturale
natural

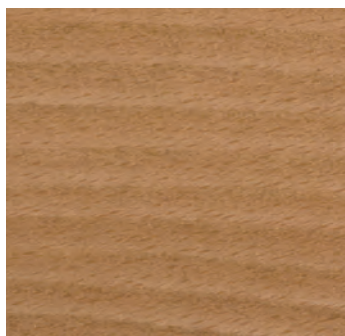

rovere
oak



ciliegio chiaro
light cherry



noce chiaro
light walnut

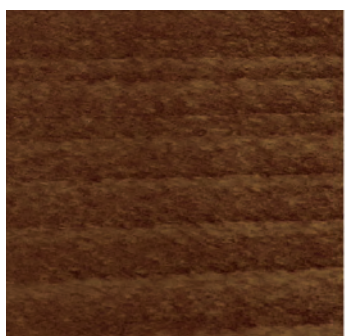

noce
walnut



noce scuro
dark walnut

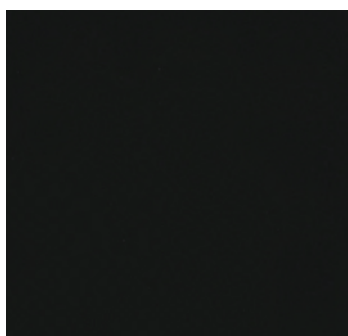

nero
black



ciliegio
cherry

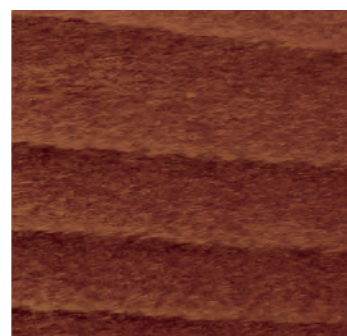

mogano
mahogany

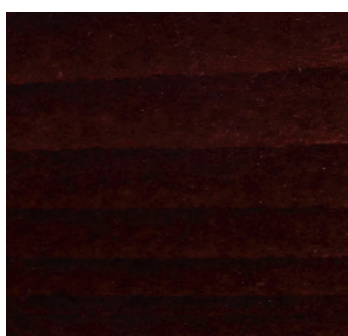

wengè
wengè



alluminio
aluminium

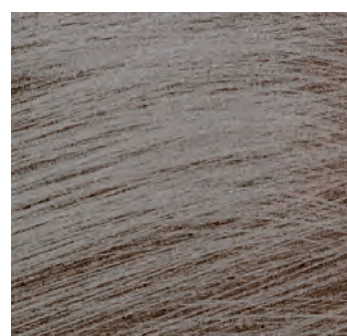

argento antico
old silver

CAMPIONARIO COLORI • AVAILABLE COLOURS

SI EFFETTUANO VERNICIATURE a CAMPIONE con un ORDINE di ALMENO 30 SEDIE o POLTRONE.
WE OFFER A CUSTOM PAINTWORK SERVICE FOR A MINIMUM ORDER OF 30 CHAIRS OR ARMCHAIRS.



beige
beige



decapè
decapè



oro
gold

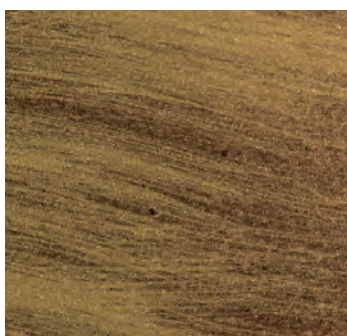

oro antico
old gold



bianco
white



bianco antico
antique white

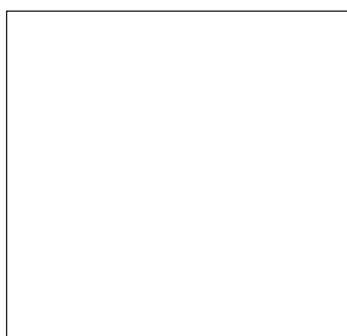

bianco brillante
glossy white

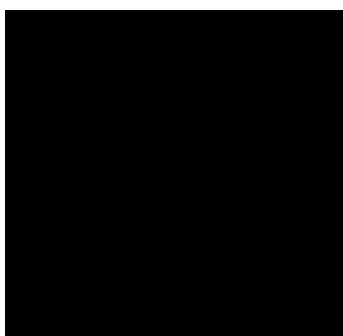

nero brillante
glossy black

Basamenti girevoli disponibili • Swivel bases available



basamento a crociera
cross-shaped base



basamento piatto
flat base



basamento conico
cone-shaped base

Lineaflex

sedie poltroncine poltrone divani
chairs armchairs sofas

MADE IN ITALY

Lineaflex srl

via L. Spallanzani, 38

20823 Birago di Lentate sul Seveso (MB)

TEL 0362 561923

FAX 0362 557923

EMAIL info@lineaflexsrl.it

www.lineaflexsrl.it